

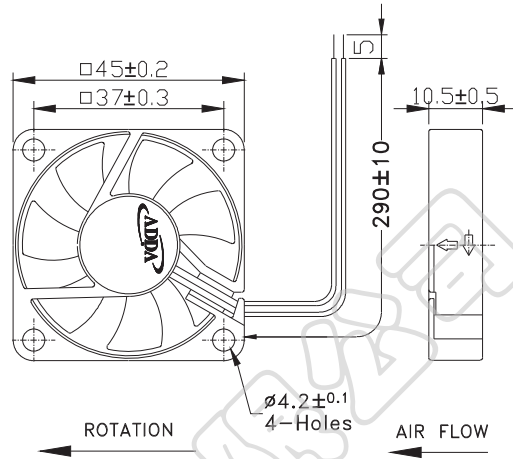

# AD4510 SERIES

## External Dimensions



Frame: Plastic (UL:94V-0)  
 Impeller: Plastic (UL:94V-0)  
 Lead wire: UL1007AWG26

## Specifications(Nominal)

\*Noise is measured at the distance of one (1) meter from the axis of intake.

Bearing type: ⊙=Ball ※=Sleeve ○=1B1S ●=Hypro bearing

Frame size (mm)	Model No.	Bearing System Type	Rated Voltage (VDC)	Current (A)	Power (W)	Rated Speed (rpm)	Maximum AirFlow (CMM)	Maximum AirFlow (CFM)	Maximum Pressure (InAq)	Maximum Pressure (mmAq)	*Noise Level (dB/A)	Weight (g)
45x45x10	AD4505LB-G70(T)	⊙ ※ ○ ●	5	0.09	0.45	3800	0.164	5.82	0.054	1.36	17.5	17.0
	AD4505MB-G70(T)	⊙ ※ ○ ●	5	0.12	0.60	4500	0.197	7.01	0.072	1.79	22.0	
	AD4505HB-G70(T)	⊙ ※ ○ ●	5	0.18	0.90	5500	0.244	8.67	0.103	2.57	27.4	
	AD4512LB-G70(T)	⊙ ※ ○ ●	12	0.06	0.72	3800	0.164	5.82	0.054	1.36	17.5	
	AD4512MB-G70(T)	⊙ ※ ○ ●	12	0.06	0.72	4500	0.197	7.01	0.072	1.79	22.0	
	AD4512HB-G70(T)	⊙ ※ ○ ●	12	0.09	1.08	5500	0.244	8.67	0.103	2.57	27.4	
	AD4524LB-G70(T)	⊙ ※ ○ ●	24	0.03	0.72	3800	0.164	5.82	0.054	1.36	17.5	
	AD4524MB-G70(T)	⊙ ※ ○ ●	24	0.05	1.20	4500	0.197	7.01	0.072	1.79	22.0	
	AD4524HB-G70(T)	⊙ ※ ○ ●	24	0.06	1.44	5500	0.244	8.67	0.103	2.57	27.4	

Specifications subject to change without notice.

The specification for bearing type is for reference only, for more bearing types information, please contact with your ADDA sales representative, thanks!!  
 (網頁上呈現產品軸承資訊均以2Ball為主, 若需其他產品資訊請聯絡您在ADDA的業務代表, 謝謝!!)

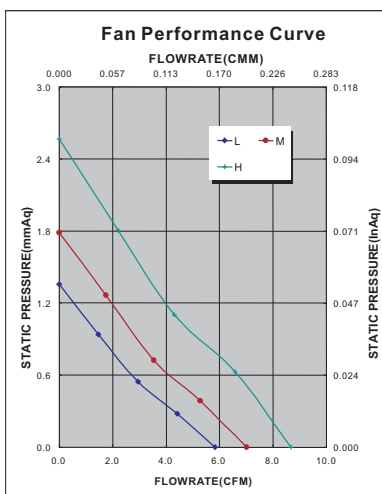

\*Motor protective circuit and third lead wire functions

0	1	2	3	4	6	7	8	9	A	B
✓	✓	✓	✓		✓					

\*Safety approvals

✓	✓		✓	✓